

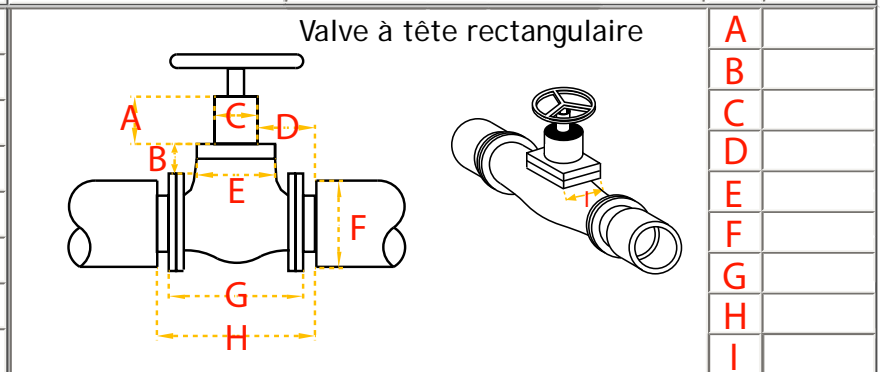

PIÈCES - THERMO AMOVIBLE [®]

Prise de mesure

Prodimax inc.
 4381, d'Angoulême, Cap-Rouge,
 Qc, Canada G1Y 2R4
 Téléphone : (418) 651-9534
 Télécopieur : (418) 651-1924

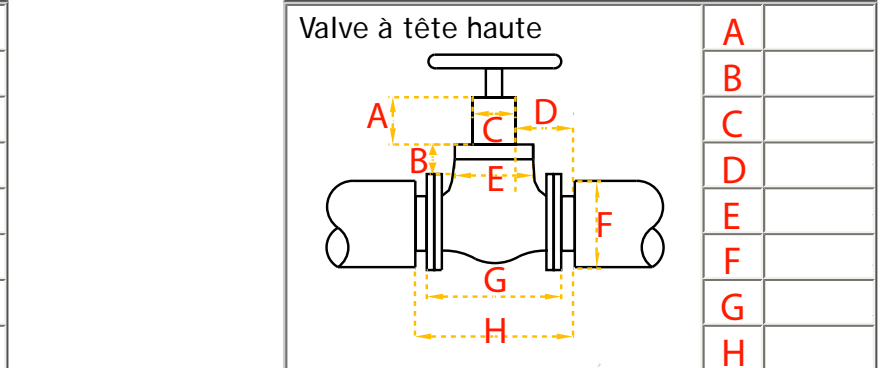
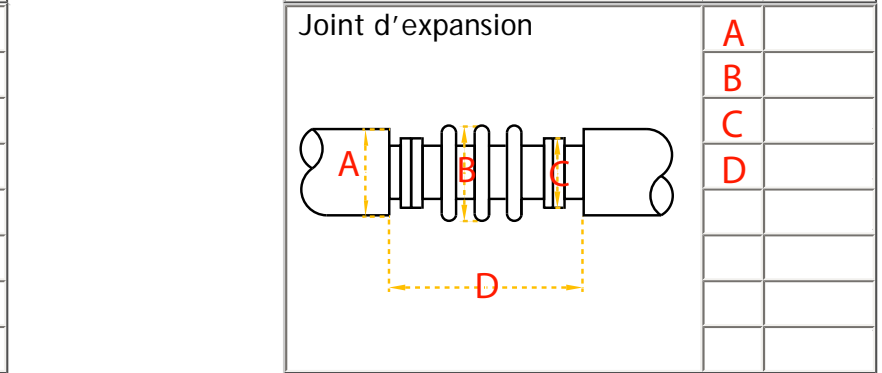
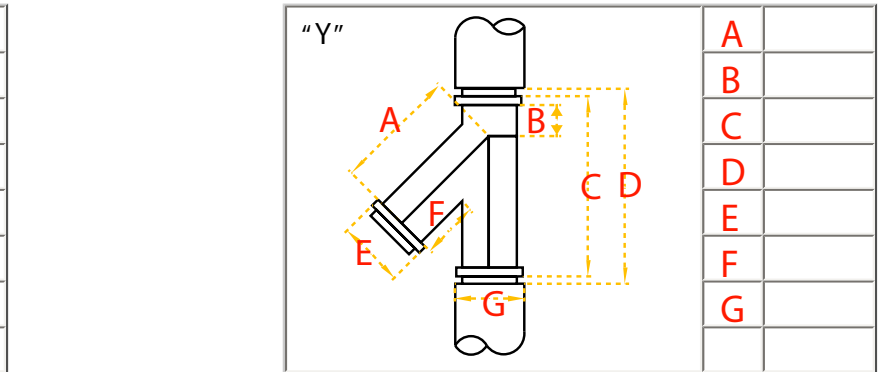
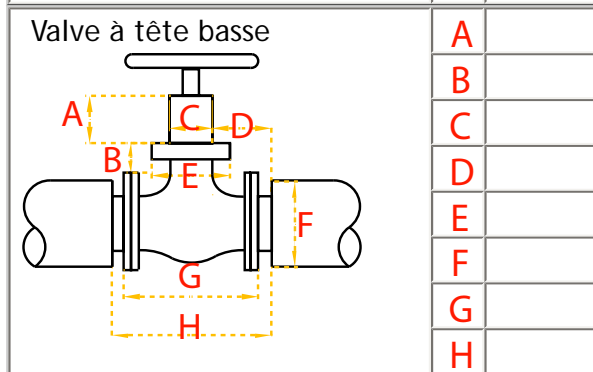
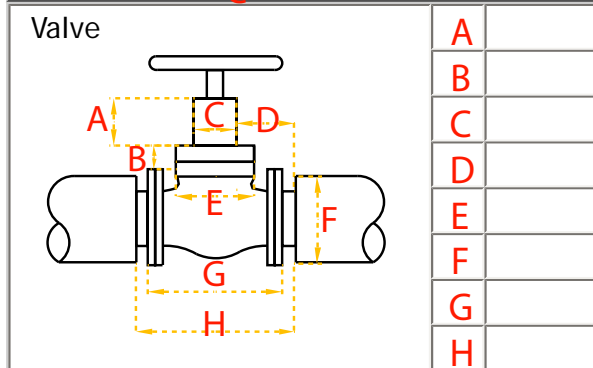
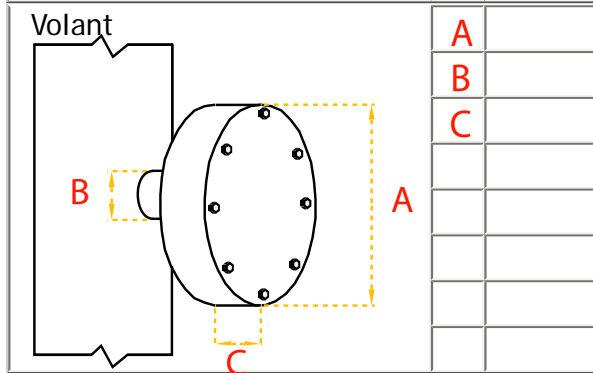
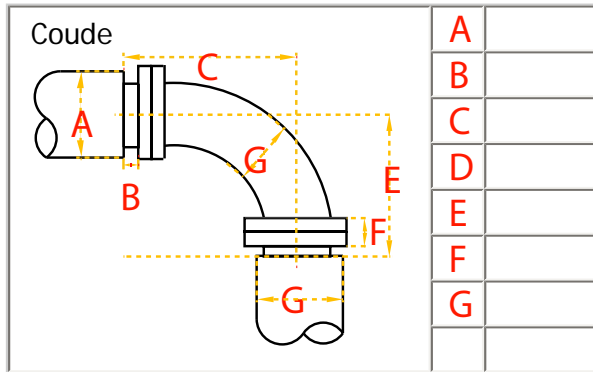

Note : _____

Spécification des conditions d'isolement _____

Température d'opération : _____

Fluide transporté (huile, vapeur, caustique, chlore...) : _____

Signature : _____ Date : _____